

SPICE thermal model

BUK962R1-40E

Symbol	Parameter	Conditions	Min	Typ	Max	Unit
$R_{th(j-mb)}$	thermal resistance from junction to mounting base		-	-	0.51	K/W

C_{th1}	2.085E-04 F
C_{th2}	1.582E-03 F
C_{th3}	1.124E-03 F
C_{th4}	4.066E-03 F
C_{th5}	1.379E-02 F
C_{th6}	2.696E-02 F
C_{th7}	6.892E-01 F
C_{th8}	1.806E+02 F
R_{th1}	4.200E-04 Ω
R_{th2}	8.136E-04 Ω
R_{th3}	9.132E-03 Ω
R_{th4}	2.352E-02 Ω
R_{th5}	8.209E-02 Ω
R_{th6}	3.277E-01 Ω
R_{th7}	7.932E-02 Ω
R_{th8}	8.874E-04 Ω

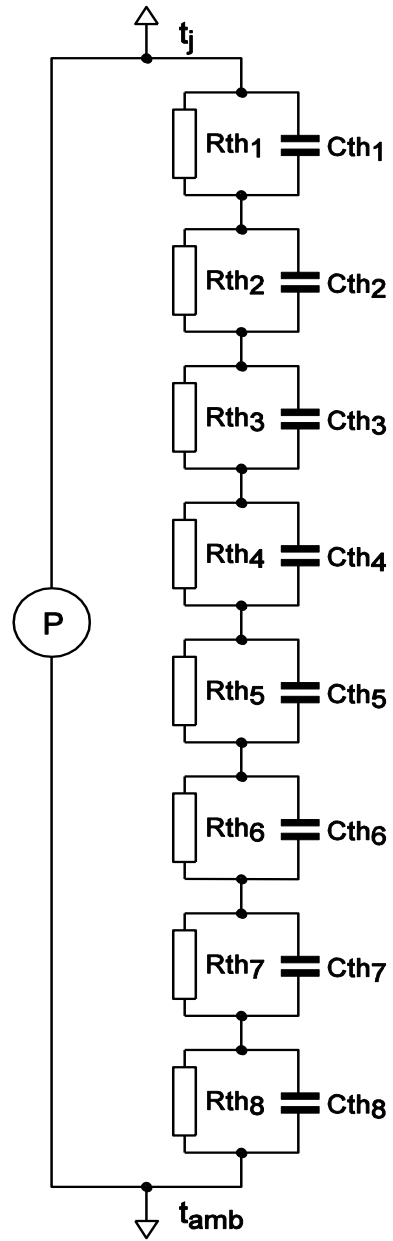

Part: BUK962R1-40E
 Date: 11/4/2013
 Model Rth 0.52 K/W